

Model #  
1000172-03

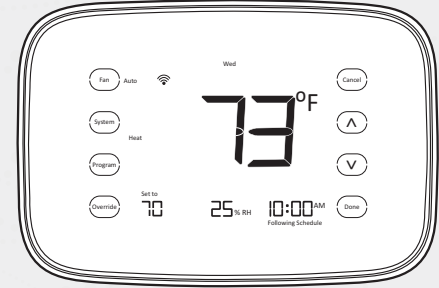

1

On the provided list of thermostat serial numbers, document the location for each thermostat.

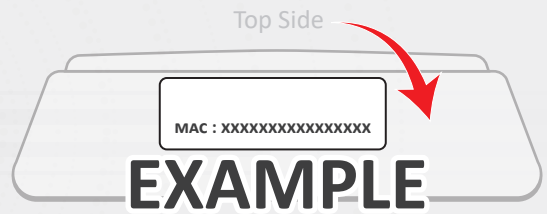

2

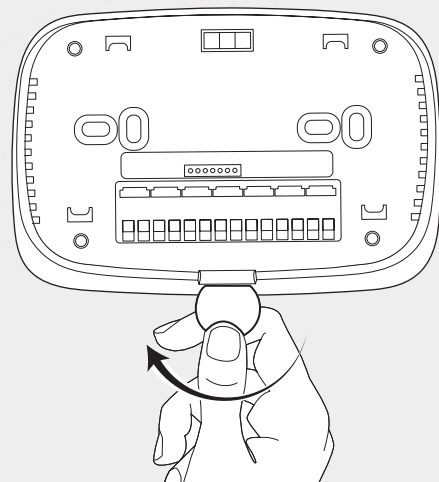

Insert a small coin (dime) in the release slot on the bottom of the thermostat and gently twist the coin to release the thermostat from the wall plate.

3

### SELECTING LOCATION FOR MOUNTING

Install the thermostat about 5 feet (1.5m) above the floor in an area with good air circulation at average temperature.

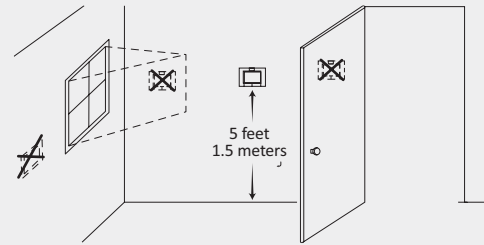

Do not install the thermostat where it can be affected by:

- Drafts or dead spots behind doors & in corners.
- Hot or cold air from ducts.
- Radiant heat from sun or appliances
- Concealed pipes and chimneys.
- Unheated or uncooled areas such as an outside wall behind the thermostat.

4

### INSTALLING WALL PLATE



Electrical hazard can cause electrical shock or equipment damage. Disconnect power before wiring.

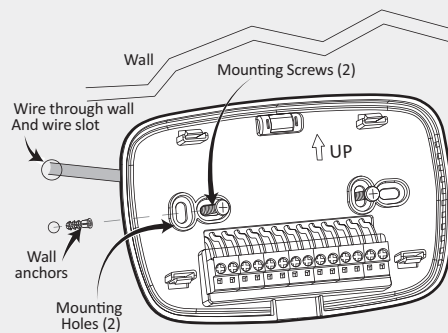

The thermostat can be mounted horizontally on the wall.

1. Position and level the wall plate.
2. Use a pencil to mark the mounting holes.
3. Remove the wall plate from the wall and drill two holes in the wall as marked. If necessary, use the provided anchors by gently tapping them into the drilled holes until flush with the wall.
4. Position the wall plate over the holes, pulling wires through the wiring opening.
5. Insert the mounting screws into the holes and tighten.

5

### WIRING

- See Table in back page for terminal designation descriptions.
- Insert wires in the terminal block under the loosened screw.
- Securely tighten each screw.
- Push excess wire back into the hole.
- Plug the hole with nonflammable insulation to prevent drafts from affecting the thermostat.

Inserting wires in terminal block

**Important:** Use 18-gauge thermostat wire.

### NOTES

1. If used in single-transformer system, leave metal jumper wire in place between RC and R. In two-transformer system, remove metal jumper wire between RC and R.
2. In a two-transformer system, connect the common from the secondary side of the heating system transformer.
3. If thermostat is configured for a heat pump system, configure changeover valve for cool or heat.
4. L terminal is an input port as system monitor.

C	R	RC	W1	W2/G3	L	Y2/G2	Y1	G1	S1	S2	← Conventional	
⊕	⊕	⊕	⊕	⊕	⊕	⊕	⊕	⊕	⊕	⊕	← Screw Terminals	
C	R	RC	E	QB	AUX	L	Y2/G2	Y1	G1	S1	S2	← Heat Pump

6

### WIRING 24VAC COMMON

#### SINGLE-TRANSFORMER SYSTEM

Connect the common side of the transformer to the C screw terminal of the thermostat wall plate. Leave the metal jumper wire in place between RC & R.

#### TWO-TRANSFORMER SYSTEM

Connect the common side of the heating transformer to the C screw terminal of the thermostat wall plate. Remove the metal jumper wire between RC and R.

7

### MOUNT THERMOSTAT TO WALL PLATE

Align the terminal screw blocks with the pins on the back of the thermostat. Push the thermostat straight onto the wall plate until it snaps into place.

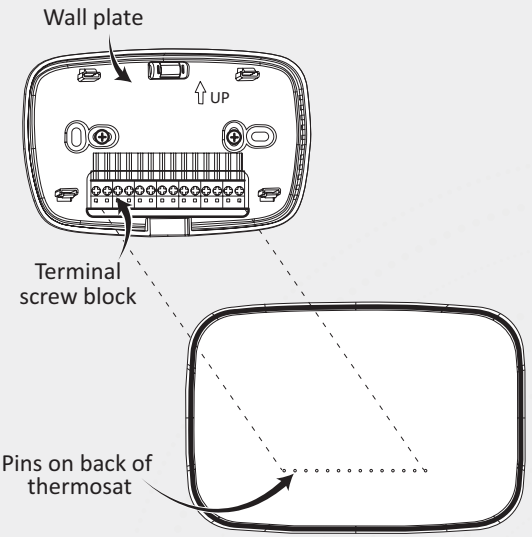

### FACTORY RESET INSTRUCTION

1. Access advanced installers menu via pressing "system" once, and then holding once equipment type begins to flash.
2. Navigate to advanced installer setting 0680 and change setting to different number between 1 and 10.
3. Press Done until Menu has been exited.

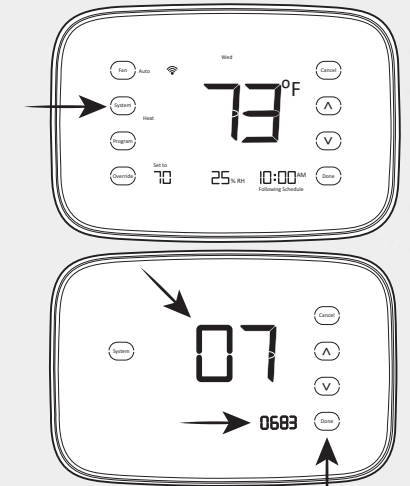

Once the Factory Reset is performed successfully, the device will search for a network and can be added through EnergyCenter®.

Terminal	Designation
RC (see note 1)	Power for cooling - connect to secondary side of cooling system transformer
R (see note 1)	Power for heating - connect to secondary side of heating system transformer
C (see note 2)	Common wire from secondary side of heating system transformer
Y1	Compressor contactor
G1	Fan relay or low fan speed
Y2/G2	Second stage cooling or medium fan speed
O/B/W1 (see note 3)	Changeover valve for heat pump systems or heat relay
W2/AUX/G3	Auxiliary heat relay for heat pump systems, 2 <sup>nd</sup> stage heat relay, high fan speed
E	Emergency heat relay for heat pump systems
L (see note 4)	Equipment monitor for heat pump systems
S1, S2	External temperature sensor

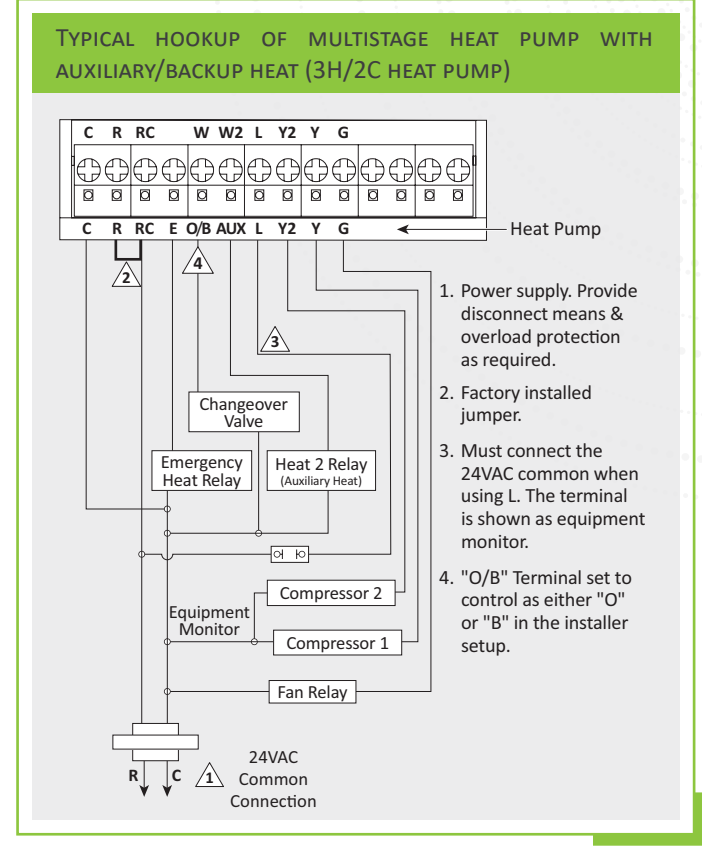
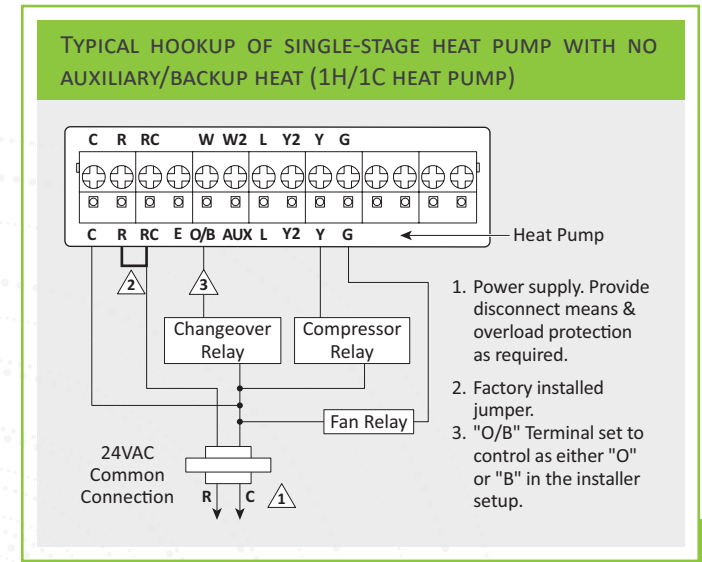
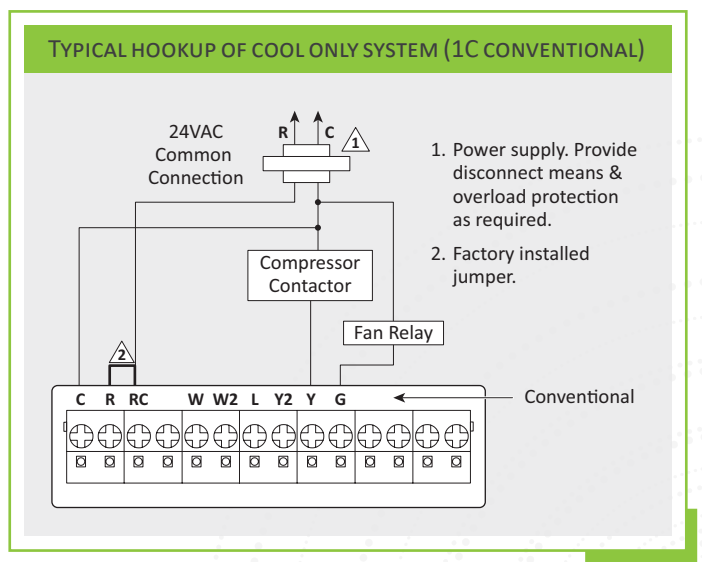
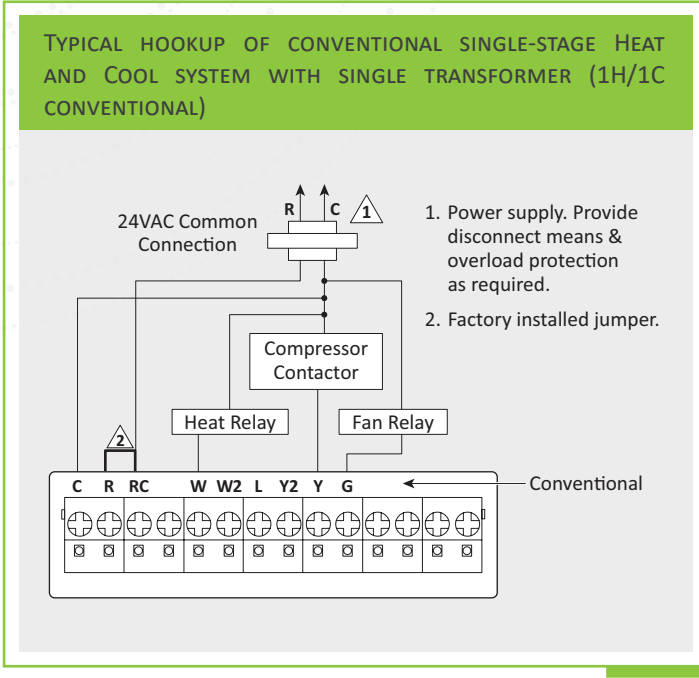
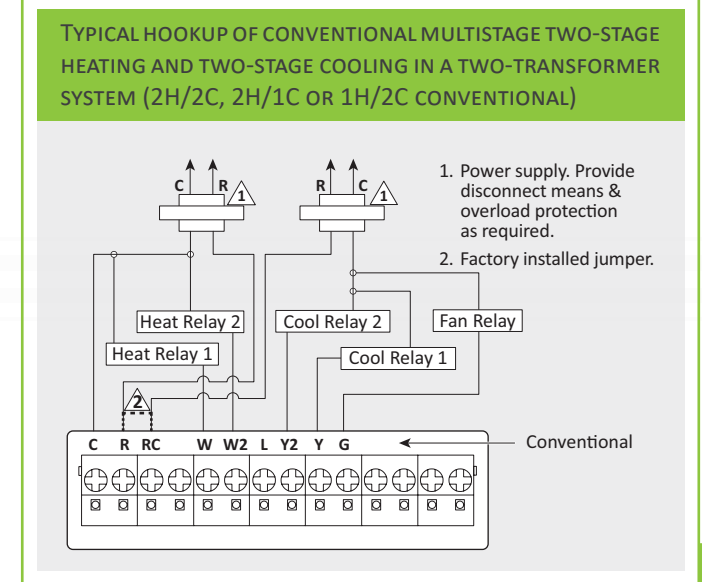
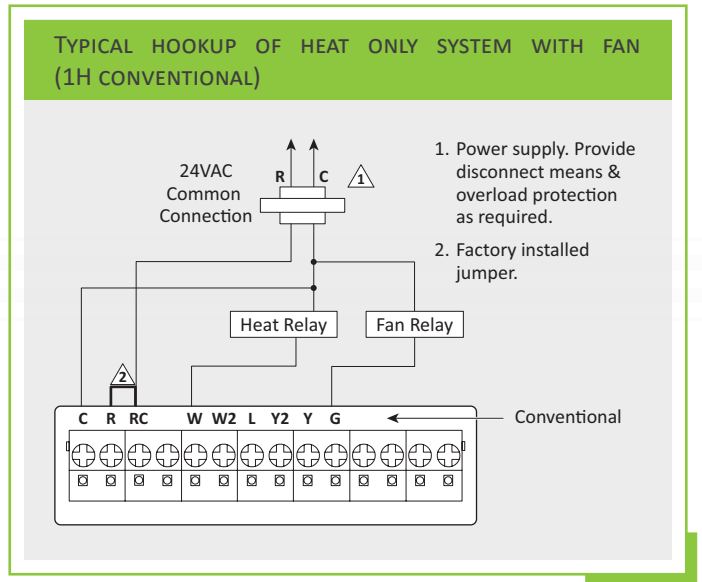
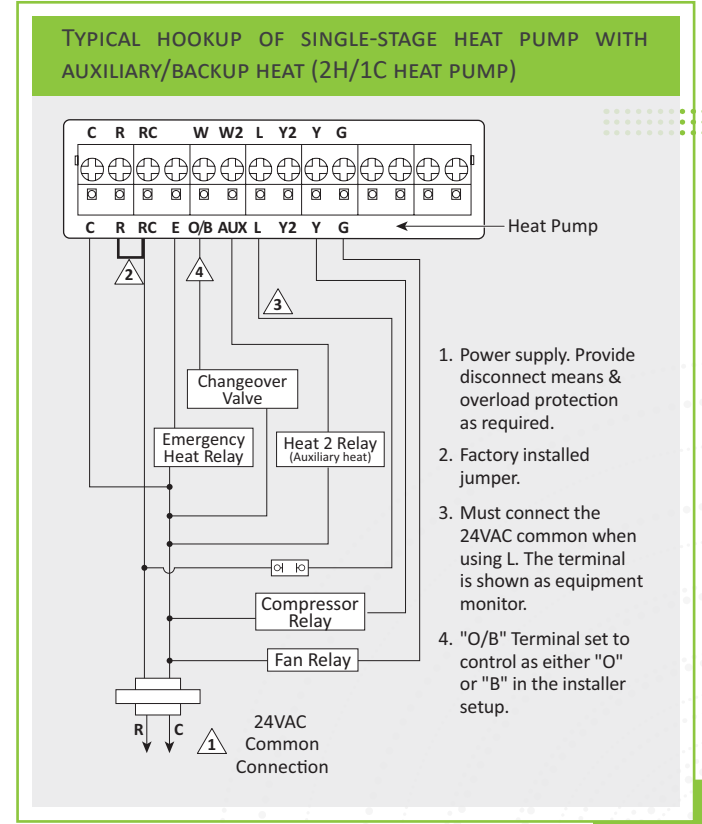
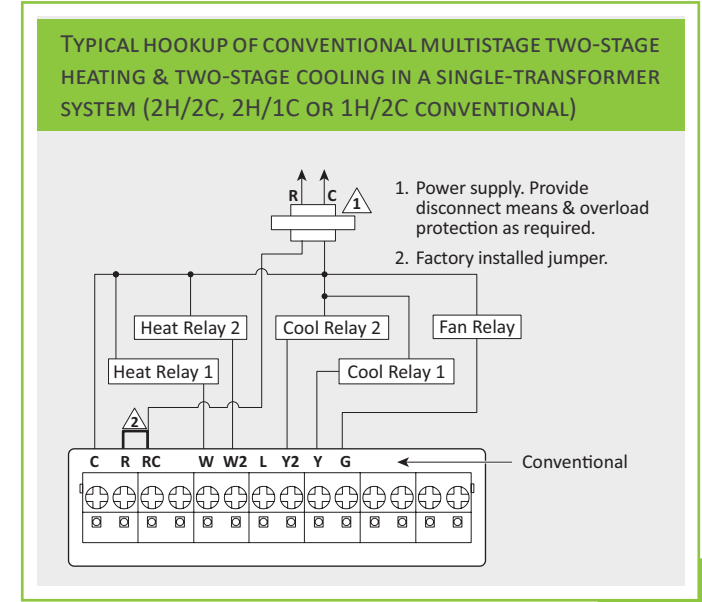
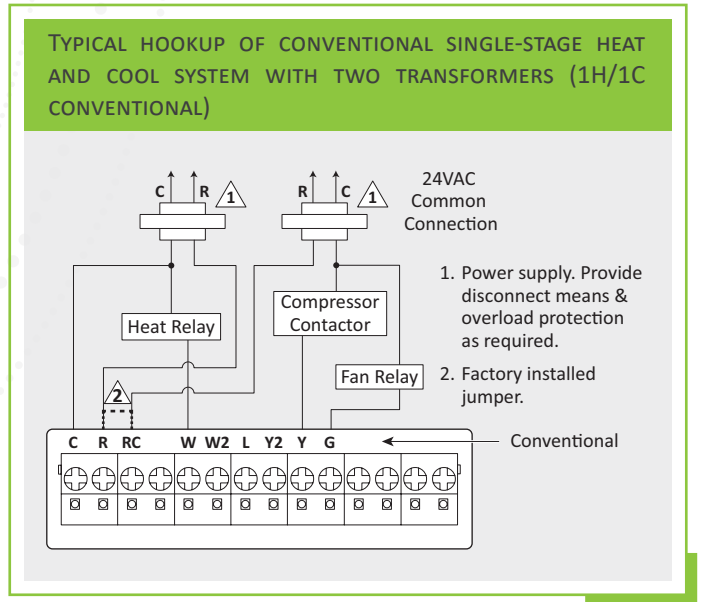

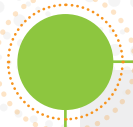

### SERIAL NUMBER INFORMATION AND TRACKING

The serial number or ID of a device is used to track device installation locations and details for the commissioning process. The identification information for each device should be tracked in a meaningful way, many devices include duplicate 'stickers' with this information. Autani provides an iOS app to assist with the process.



For help getting starting with the iOS Commissioning App please see Autani's User Guide for the iOS Commissioning App.



Once commissioning details are collected, either through the iOS Commissioning App, or by tracking identifiers on drawings/spreadsheets. Please provide this information to support@autani.com to begin the commissioning process.