



User Guide

Integrated Wireless T-32-P Thermostat



Autani LLC

7090 Columbia Gateway Drive, Suite 140, Columbia, MD 21046, USA,
(443) 320-2233 | (240) 755-0092 (fax) www.autani.com.

This document contains the Proprietary and Confidential Information of Autani LLC. Any use of this information without the expressed written consent of Autani, LLC is prohibited. Copyright Autani LLC, 2010-2020. All rights reserved. Please refer to www.autani.com/legal for licensing, intellectual property, and other legal notices and information.

Table of Contents

1. Installing Thermostats	3
1.1. Locating Thermostats.....	3
1.2. Opening the Thermostat.....	3
1.3. Mounting a Thermostat Subbase.....	4
1.4. Terminal Designations	4
1.5. Typical Wiring Diagrams and Switch Settings	5
1.6. Dual Fuel Applications.....	8
2. Setting the System Switches	9
2.1. Activating the Battery	10
3. Accessing the Settings Menu	11
4. Installing Remote Sensors	14
4.1. Types of Remote Sensors.....	14
4.2. Installing Indoor Sensor Guidelines	14
4.3. Installing Outdoor Sensor Guidelines	14
4.4. Calibrating Sensors.....	14
5. Wiring Sensors	15
5.1. Function Overview for ‘T’ Terminals.....	15
5.2. Wiring Outdoor Sensors.....	15
5.3. Wiring Indoor Sensors.....	15
5.4. Wiring Sensors for Indoor Temperature Averaging.....	15
5.5. Wiring Multiple Sensors for Indoor Temperature Averaging	16
5.6. Wiring to Turn Off Thermostats Remotely	16
5.7. Wiring to Override Settings Remotely	16
6. Testing	17
6.1. Disabling and Resetting Thermostat Delays	17
6.2. Testing Fan Operation.....	17
6.3. Testing Conventional Systems	17
6.4. Testing Heat Pumps	17
6.5. Using Factory Test Mode	18
7. Basic Troubleshooting	19
8. Specifications	20

1. Installing Thermostats

This Installation Guide contains installer setup functions which, if not correctly set, may cause damage to the HVAC equipment, or seriously affect performance. There are no user-serviceable parts inside the T-32-P. Unauthorized dismantling will void the warranty. For warranty information, see www.autani.com/legal.

1. Thoroughly read this Installation Guide.
2. Install the T-32-P.
3. Set the eight system switches to match the equipment application.
4. Wire the optional remote temperature sensor(s).
5. Power the thermostat.
6. Select options in the Settings menu.
7. Program and setup the T-32-P thermostat. Refer to the T-32-P User's Manual.
8. Test heating, cooling, and other functions.

1.1. Locating Thermostats

Install the T-32-P in a location that represents the ambient space temperature. Do not install thermostats on an external wall or in areas:

- Where air movement is limited
- Affected by direct sunlight
- Near lamps or appliances
- Where there may be drafts
- Near the floor
- Behind doors

1.2. Opening the Thermostat

1. Insert a small coin (such as a dime) in the release slot located on the bottom of the thermostat.
2. Gently twist the coin to release the thermostat from the subbase.

Avoid twisting the case to protect the LCD screen and avoid bending the terminal connector pins.

Figure 1. Opening the T-32-P

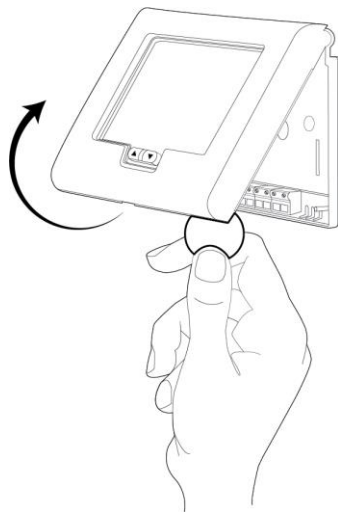

1.3. Mounting a Thermostat Subbase

1. Pull the control wires through the large opening in the thermostat subbase.
2. Level and mount the subbase on the wall using the supplied anchors and screws. Do not over tighten the mounting screws as the subbase may warp causing the improper seating of the thermostat connecting pins to the terminal blocks.
 - Do not over tighten the mounting screws as the subbase may warp causing the improper seating of the thermostat connecting pins to the terminal blocks.
 - Use a properly sized screwdriver to connect each wire to its dedicated terminal.
 - Do not over tighten the terminal screws.
 - Check to ensure that all wires are connected correctly and dressed properly to prevent any shorts.
3. Seal the control wire hole to prevent drafts in the wall cavities that can affect the internal temperature sensor.

Figure 2. Subbase Mounting

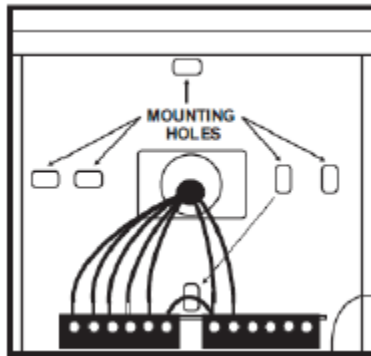

1.4. Terminal Designations

Based on the T-32-P slide switch configuration, some terminals have multiple output functions.

Figure 3. Terminal Designations

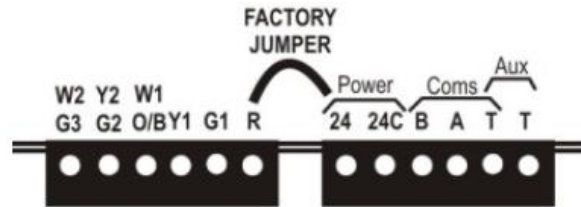

Terminal	Designation
W2	Second stage heating or auxiliary heat
Y2	Second stage compressor
W1	First state heating
O/B	Reversing Valve
Y1	First stage compressor
G1	Fan relay
R	24 volt hot (jumpered to '24')
24	24 volt hot
24C	24 volt common
B	Modbus communications
A	Modbus communications
T	Auxiliary input terminal
T	Auxiliary input terminal

1.5. Typical Wiring Diagrams and Switch Settings

Figure 4. Wiring Diagram: Heat Only

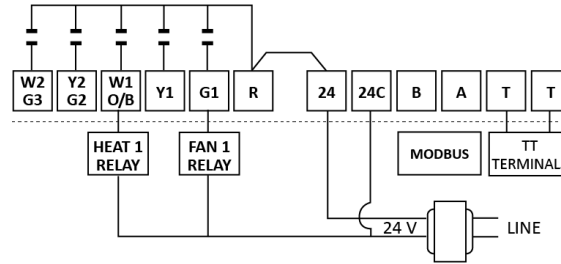

Switch Settings

Sw1 = OFF – Fan Relay

Sw2 = OFF – Heat/Cool

Sw3 = OFF – Single Stage

Sw4 = OFF – Equipment Controls Fan

Sw5 = Installer Preference

OFF – No Short Cycle Protection

ON – 4 Minute Short Cycle Protection

Sw6 = OFF – Non-programmable

Sw7 = Installer Preference

OFF – 2 Minute Minimum Run Time

ON – 6 Minute Minimum Run Time

Sw8 = ON – 2 Setpoints

NOTE: Set FN to H in the Settings menu. See Accessing the Settings Menu section.

Figure 5. Wiring Diagram: 1 Heat/1 Cool

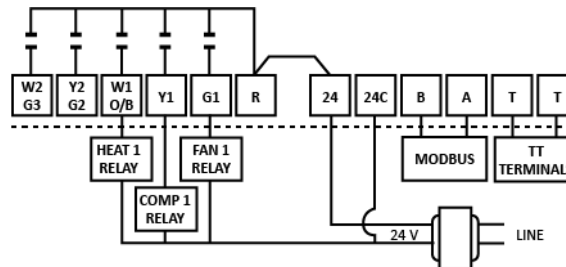

Switch Settings

Sw1 = OFF – Fan Relay

Sw2 = OFF – Heat/Cool

Sw3 = OFF – Single Stage

Sw4 = OFF – Equipment Controls Fan

Sw5 = Installer Preference

OFF – No Short Cycle Protection

ON – 4 Minute Short Cycle Protection

Sw6 = OFF – Non-programmable

Sw7 = Installer Preference

OFF – 2 Minute Minimum Run Time

ON – 6 Minute Minimum Run Time

Sw8 = ON – Separate Heat and Cool Setpoints

Figure 6. Wiring Diagram: 2 Heat/2Cool

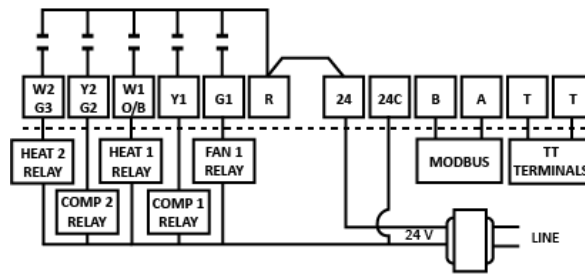

Switch Settings

- Sw1 = OFF – Fan Relay
- Sw2 = OFF – Heat/Cool
- Sw3 = ON – Two Stage
- Sw4 = OFF – Equipment Controls Fan
- Sw5 = Installer Preference
 - OFF – No Short Cycle Protection
 - ON – 4 Minute Short Cycle Protection
- Sw6 = OFF – Non-programmable
- Sw7 = Installer Preference
 - OFF – 2 Minute Minimum Run Time
 - ON – 6 Minute Minimum Run Time
- Sw8 = ON – Separate Heat and Cool Setpoints

Figure 7. Wiring Diagram: 2 Heat/1 Cool Heat Pump

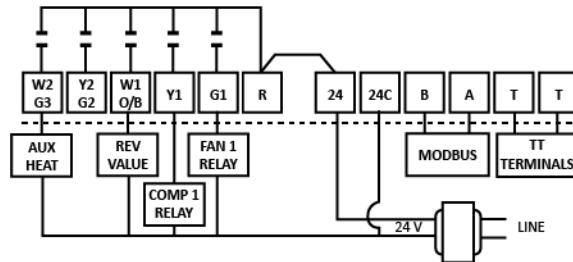

Switch Settings

- Sw1 = OFF – Fan Relay
- Sw2 = ON – Heat Pump
- Sw3 = OFF – Single Stage
- Sw4 = Reversing Valve
 - OFF – O = RV Energized in Cooling
 - ON – B = RV Energized in Heating
- Sw5 = Installer Preference
 - OFF – No Short Cycle Protection
 - ON – 4 Minute Short Cycle Protection
- Sw6 = OFF – Non-programmable
- Sw7 = Installer Preference
 - OFF – 2 Minute Minimum Run Time
 - ON – 6 Minute Minimum Run Time
- Sw8 = ON – Separate Heat and Cool Setpoints

Figure 8. Wiring Diagram: 3 Heat/2 Cool Heat Pump

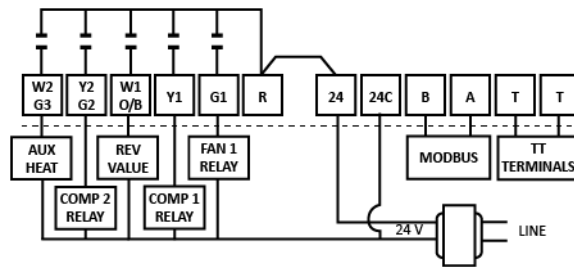

Switch Settings

- Sw1 = OFF – Fan Relay
- Sw2 = ON – Heat Pump
- Sw3 = ON – Two Stage
- Sw4 = Reversing Valve
 - OFF – O = RV Energized in Cooling
 - ON – B = RV Energized in Cooling
- Sw5 = Installer Preference
 - OFF – No Short Cycle Protection
 - ON – 4 Minute Short Cycle Protection
- Sw6 = OFF – Non-programmable
- Sw7 = Installer Preference
 - OFF – 2 Minute Minimum Run Time
 - ON – 6 Minute Minimum Run Time
- Sw8 = ON – Separate Heat and Cool Setpoints

Figure 9. Wiring Diagram: 2 Heat/1 Cool Dual Fuel

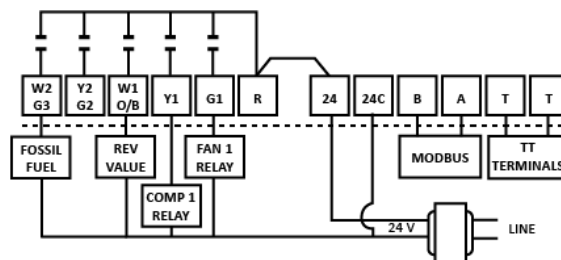

Switch Settings

- Sw1 = OFF – Fan Relay
- Sw2 = ON – Heat Pump
- Sw3 = ON – Single Stage
- Sw4 = Reversing Valve
 - OFF – O = RV Energized in Cooling
 - ON – B = RV Energized in Cooling
- Sw5 = Installer Preference
 - OFF – No Short Cycle Protection
 - ON – 4 Minute Short Cycle Protection
- Sw6 = OFF – Non-programmable
- Sw7 = Installer Preference
 - OFF – 2 Minute Minimum Run Time
 - ON – 6 Minute Minimum Run Time
- Sw8 = ON – Separate Heat and Cool Setpoints

Figure 10. Wiring Diagram: 3 Heat/2 Cool Dual Fuel

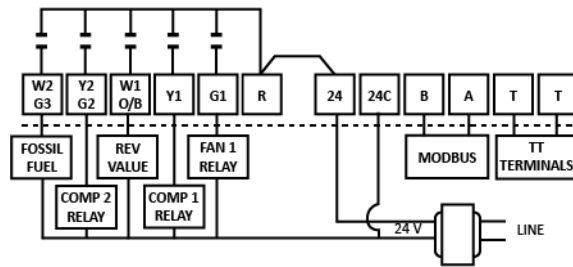

Switch Settings

Sw1 = OFF – Fan Relay

Sw2 = ON – Heat Pump

Sw3 = ON – Two Stage

Sw4 = Reversing Valve

OFF – O = RV Energized in Cooling

ON – B = RV Energized in Cooling

Sw5 = Installer Preference

OFF – No Short Cycle Protection

ON – 4 Minute Short Cycle Protection

Sw6 = OFF – Non-programmable

Sw7 = Installer Preference

OFF – 2 Minute Minimum Run Time

ON – 6 Minute Minimum Run Time

Sw8 = ON – Separate Heat and Cool Setpoints

1.6. Dual Fuel Applications

When the T-32-P is used with dual fuel systems, an outdoor sensor is recommended for balance point control.

1. Wire the sensor to the 'T' terminals on the thermostat.
2. In the Settings menu:
 - a. Set TT to OA to configure the thermostat to receive outdoor temperature information.
 - b. Select high and low balance point settings.
 - High balance point range is 32°F-122°F. Factory default is 55°F.
 - Low balance point range is 15°F-77°F. Factory default is 35°F.
 - c. ⚠ Configure the W2 relay to lock out the heat pump at the low balance point or whenever the thermostat calls for auxiliary or emergency heat. Set H3 to FF.

2. Setting the System Switches

The T-32-P printed circuit board contains a set of eight system switches. The switches are used to match the thermostat with the type of system being used and user preferences.

The function of each switch is described in the table below. For information on switch settings by specific system configuration, see the section entitled Typical Wiring Diagrams and Switch Settings.

Table 2. Switch Functions and Settings

Switch	Function	Setting
Sw1	Fan Relay	Leave switch in OFF position (factory default).
Sw2	Equipment Configuration	<ul style="list-style-type: none"> Heat/cool equipment: leave switch in OFF position (factory default). Heat pump: Set switch to ON position.
Sw3	Equipment Stages	<ul style="list-style-type: none"> Single stage equipment: leave switch in OFF position (factory default). Multistage equipment: Set switch to ON position.
Sw4	Fan Mode for heat/cool systems Reversing valve for heat pumps	<ul style="list-style-type: none"> Fan mode <ul style="list-style-type: none"> Gas or oil systems (equipment controls fan in heating mode): leave switch in OFF position (factory default). Electric systems (thermostat controls fan in heating mode): set switch to ON position. Reversing Valve <ul style="list-style-type: none"> “O” reversing valve (energize cooling): leave switch in OFF position (factory default). “B” reversing valve (energize heating): set switch to ON position.
Sw5	Short Cycle Timer	Leave switch in ON position for four-minute short cycle protection (factory default).
Sw6	Thermostat Operation	Leave switch in OFF position for non-programmable mode (factory default).
Sw7	Minimum Run Time	Leave switch in OFF position for two-minute minimum run time (factory default).
Sw8	Program Schedule	Leave switch in ON position for separate heating and cooling setpoints (factory default).

Figure 11: System Switches

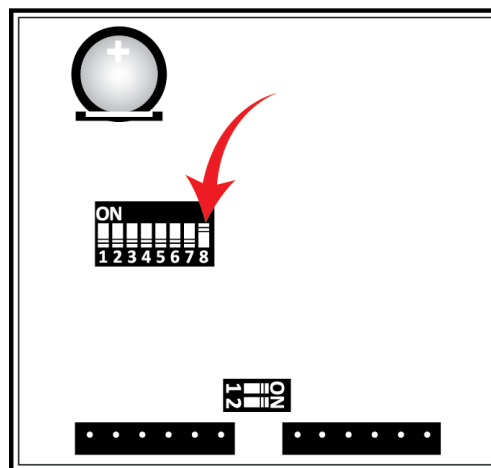

Table 3. Factory Default Switch Settings

Switch	Default	Function
Sw1	OFF	Fan relay
Sw2	OFF	Heat/cool equipment
Sw3	OFF	Equipment stages
Sw4	OFF	Fan control/Reversing valve
Sw5	ON	Four minute short cycle protection
Sw6	OFF	Non-programmable

2.1. Activating the Battery

The T-32-P contains a 3-volt lithium cell battery that maintains the time of day in the event of a power failure. If there is a white tab, carefully remove it to activate the battery.

Figure 12. Removing the Battery Tab

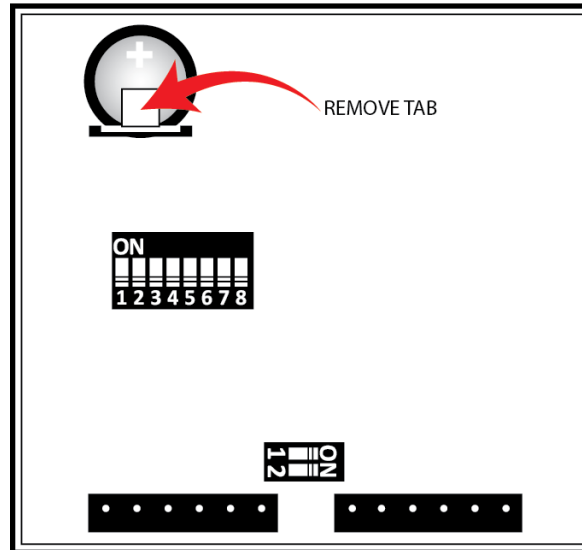

3. Accessing the Settings Menu

1. Press the O/RIDE button once and hold it down until the number “88:15” is displayed on the LCD screen (about 15 seconds).
2. Using the arrow button, adjust the value until it reads “88:32” and then press the O/RIDE button to enter the menu.
3. To navigate through the menu, press the O/RIDE button to move forward or the PROG button to move backwards

Table 4. Settings Menu Options

Symbol	Default	Function/Setting Options
PN	32	<ul style="list-style-type: none"> • Keyboard Lock PIN. required to enter the menu. • Range is 00-99.
LC	00	Keyboard Lock OFF
Programmable Mode (Sw6=ON)		All buttons are locked except: <ul style="list-style-type: none"> • 01 – ▲ and ▼ buttons • 02 – O/RIDE and ▲ and ▼ • 03 – MODE, O/RIDE and ▲ and ▼ • 04 – MODE and ▲ and ▼ • 05 – O/RIDE • 06 – All buttons are locked.
Manual Mode (Sw6=OFF)		<ul style="list-style-type: none"> • 00 – Keyboard lock OFF • 01 – All buttons are locked except MODE. • 02 – All buttons are locked except MODE and ▲ and ▼. • 03 – FAN and PROG are locked. MODE button can only select Auto or OFF. • 04 – MODE button can only select Auto or OFF. • 05 – All buttons are locked. • 06 – All buttons are locked.
HL	90	<ul style="list-style-type: none"> • Maximum heating or high temperature limit • Range using LCD is 41°F-120°F. • Range using Autani EnergyCenter is 41°F-98°F.
CL	50	<ul style="list-style-type: none"> • Minimum cooling or low temperature limit • Range using LCD is 43°F-122°F. • Range using Autani EnergyCenter is 43°F-98°F.
CF	F	<ul style="list-style-type: none"> • Temperature Display • Degrees F or C
C1	0.0	<ul style="list-style-type: none"> • Internal Sensor Calibration • Range is +/- 9°F, in increments of tenths of a degree.
TC	12	<ul style="list-style-type: none"> • Time Format • 12 or 24 Hour Clock
TD	0	<ul style="list-style-type: none"> • 0 – Displays set and space temperatures. • 1 – Displays only the set temperature
AH	2.0	<ul style="list-style-type: none"> • After hours override timer • Range is OFF to 12, in increments of half an hour.
4 Schedules (Sw6=ON) (Sw8=ON)		<ul style="list-style-type: none"> • Temporary program override 0 (OFF) extends override until the next program change. • Range is 1-12 override hours.

Symbol	Default	Function/Setting Options
SC	OF	Factory default – Do not change.
SH	OF	Factory default – Do not change.
DB	2	Factory default – Do not change.
FO	0	<ul style="list-style-type: none"> 0 – Fan runs continuously in ON mode. 1 – Fan continues to run after cooling cycle but not heating cycle. 2 – In programmable mode (Sw6=ON), fan runs continuously with program 1 through 4 and then in AUTO from program 4 through 1. 3 – In programmable mode (Sw6=ON), fan control is a combination of options 1 and 2.
FP	0	<ul style="list-style-type: none"> Fan Purge Range is 0-5 minutes after heating or cooling cycle
FN	A	<ul style="list-style-type: none"> A – Mode for heating/cooling system C – Cooling only system H – Heating only system
H3	OF	<ul style="list-style-type: none"> OF – W2 relay only operates as auxiliary heat in heat pump mode (Sw1=OFF; Sw2=ON). EH – W2 relay controls emergency heat. AH – Do not use this function. AL – W2 relay used for auxiliary and emergency heat. FF – Fossil Fuel (Y is locked out when W2 is energized.)
TT	RS	<ul style="list-style-type: none"> RS – For NO remote sensor or 1 or more remote indoor sensors without the onboard sensor being used OA – For outdoor remote sensor connection DA – Sends measured temperature from remote sensor via Modbus but does not display the value on the LCD. OC – For connecting dry contact switch used to replace user set points with preprogrammed cooling and heating setpoints (OC/OH) OF – For connecting dry contact switch used to turn thermostat off when closed AV – For combined average from the internal thermostat sensor and remote indoor sensor(s).
AF	1	<ul style="list-style-type: none"> 1 – Freeze protection ON. If thermostat is OFF, heating comes on if room temperature falls below 41°F. 0 – No freeze protection
OH	OF	<ul style="list-style-type: none"> Override heating setpoint Range is 41°F-120°F.
OC	OF	<ul style="list-style-type: none"> Override cooling setpoint Range is 43°F-122°F.
SP	2	<ul style="list-style-type: none"> 2 – 1.9° F differential for stage 1 1 – 1.4°F differential 3 – 2.4°F differential
SD	2	<ul style="list-style-type: none"> 2 – 1.9°F differential for stage 2 1 – 1.4°F differential 3 – 2.4°F differential
DT	20	<ul style="list-style-type: none"> Upstage timer Range is 10-90 minutes, in five minute increments. Only works if thermostat has not called for second or third stage and Sw3=ON.
OS	1	<ul style="list-style-type: none"> 1 – Adaptive Recovery ON 0 – Adaptive Recovery OFF

Symbol	Default	Function/Setting Options
C2	0.0	<ul style="list-style-type: none"> Remote sensor calibration Range is +/- 9°F, in increments of half a degree.
CO	55	<ul style="list-style-type: none"> When outdoor temperature falls below setpoint, cooling shuts off. Range using LCD is 43°F-122°F. Range using Autani EnergyCenter is 43°F-98°F. Only works if TT=OA with outdoor sensor.
HO	75	<ul style="list-style-type: none"> When outdoor temperature rises above setpoint, heating shuts off. Range using LCD is 41°F-120°F. Range using Autani EnergyCenter is 41°F-98°F. Only works if TT=OA with outdoor sensor.
HB	55	<ul style="list-style-type: none"> High Balance Point W2 auxiliary heat is locked out when temperature rises above HB setpoint. Options are 32°F-122°F and OFF. Only works if TT=OA with outdoor sensor and H3=FF for fossil fuel.
LB	35	<ul style="list-style-type: none"> Low Balance Point W2 auxiliary heat is locked out when temperature falls below LB setpoint. Options are 14°F-77°F and OFF. Only works if TT=OA with outdoor sensor and H3=FF for fossil fuel.
FT	OF	<ul style="list-style-type: none"> Replace or clean filter Range is Off to 90 hours, in 10 hour increments.
AD	1	<ul style="list-style-type: none"> Modbus Address Must be set to 1.
BD	19.2	<ul style="list-style-type: none"> 19.2 baud rate 9.6 baud rate 4.8 baud rate
CD	0	<ul style="list-style-type: none"> 0 – Commissioning Mode OFF; all time delays active 1 – Commissioning Mode ON; all time delays inactive
SS	0	<ul style="list-style-type: none"> 0 – Start/Stop mode controlled by thermostat program 1 – Thermostat Start only mode per call by Modbus Master 2 – Thermostat Stop only mode per call by Modbus Master
RS	50	<ul style="list-style-type: none"> Response Time – Do not change factory default.
TS	0	<ul style="list-style-type: none"> 0 – Factory Test Mode OFF 1 – Display configuration code 2 – Step cycle all relays in sequence 3 – Reset software to factory defaults (Press the Fan button to initiate.)

4. Installing Remote Sensors

4.1. Types of Remote Sensors

Depending on the thermostat configuration, the T-32-P can use an indoor remote sensor or multiple sensors:

- For temperature averaging
- As an outdoor sensor for temperature display
- As a control function

There are two types of remote sensors.

- The T-32-S1 is a single sensor that can be used indoors or outdoors.
- The T-32-S2 contains two sensors. A combination of both sensors can be used for indoor temperature averaging to simplify wiring.

4.2. Installing Indoor Sensor Guidelines

Locate the sensor in the same manner as a thermostat.

- Mount the sensor 18" away from outside walls.
- Do not install the sensor behind doors, in corners or other dead air spaces.
- Keep the sensor away from direct air flow, supply registers, or sources of heat such as lamps and appliances.
- The maximum wire length from the sensor to the thermostat is 300 feet.
- Use a separate 18-2 thermostat cable for sensor wiring.
- Prior to wiring the sensor to the thermostat, use an ohm-meter or multimeter to measure the resistance of the sensor. Measure at the end of the wires that will connect to the thermostat. Confirm the resistance value (within 5%) to the temperature where the sensor is mounted.
- Disconnect power to the thermostat when wiring the sensor to the T terminals. Strip only as much insulation off the wires as necessary to provide a good contact with the terminals. The sensor is not polarity specific so either sensor lead may be connected to either terminal.

4.3. Installing Outdoor Sensor Guidelines

- Mount the sensor on a vertical exterior surface below an overhang.
- Choose a location protected from direct sunlight and exposure to excessive moisture.
- Follow the same wiring and test procedures as installing an indoor sensor.

4.4. Calibrating Sensors

Table 5. Sensor Calibration Chart

Temperature (F°)	Resistance (10kΩ)	Temperature (F°)	Resistance (10kΩ)
30	34.6	70	11.9
40	26.1	80	9.4
50	19.9	90	7.4
60	15.3	100	5.9

5. Wiring Sensors

5.1. Function Overview for 'T' Terminals

The 'T' terminals on the thermostat are primarily used to wire an indoor or outdoor remote sensor. The terminals are not polarity dependent. Depending on the thermostat configuration, the terminals can also be used for other functions such as remote ON/OFF switching of various control functions. Each configuration requires setup using the Setting menu. For more information, see the section entitled Accessing the Settings Menu.

5.2. Wiring Outdoor Sensors

To use the T-32-S1 as an outdoor sensor and display the outside air temperature on the T-32-P:

Wire the sensor to the thermostat as shown using separate 18-2 thermostat cable.

In the Settings menu, set TT to OA.

If the outdoor sensor fails, or is not wired properly, two dashes will appear on the LCD where the outside temperature would normally be displayed. The outdoor sensor can also be used for high and low balance point control in dual fuel systems. For more information, see the *Dual Fuel Applications* section.

Figure 13. Wiring Diagram: Outdoor Sensor

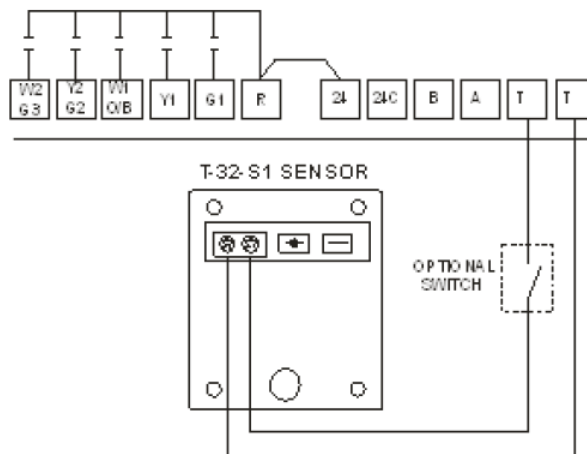

5.3. Wiring Indoor Sensors

To use the T-32-S1 as an indoor sensor and configure the T-32-P to allow only the remote sensor to control the temperature:

1. Wire the sensor as shown in Figure 13.
2. In the Settings menu, set TT to RS.

5.4. Wiring Sensors for Indoor Temperature Averaging

To use temperature averaging with or without the thermostat onboard sensor, multiple sensors can be connected to the 'T' terminals. The total value of remote sensors wired in series/parallel must equal $10k\Omega$ @ $77^{\circ}F$. The onboard sensor is not part of the equation.

To use a single T-32-S1 as an indoor sensor, wire the sensor as shown in Figure 13.

- To use both the remote and onboard sensor for temperature averaging, in the Settings menu set TT to AV.
- To use an optional in-line switch to change the temperature sensing location from the remote to the onboard sensor, in the Settings menu set TT to RS.

5.5. Wiring Multiple Sensors for Indoor Temperature Averaging

- See Figure 14 for wiring two T-32-S2 sensors.
- For three sensors, one T-32-S2 and two T-32-S1 sensors can be wired in series/parallel.
- For four sensors, four T-32-S1 sensors can be wired in series/parallel.

Configurations of multiple sensors can be used with or without the thermostat onboard sensor.

- To include the onboard sensor, in the Settings menu set TT to AV.
- To exclude the onboard sensor, in the Settings menu set TT to RS.

Figure 14. Wiring Diagram: Indoor Sensors

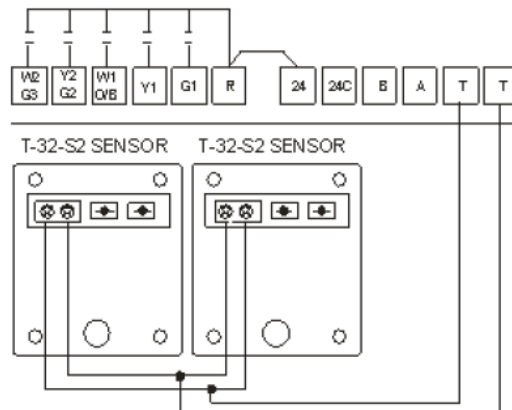

5.6. Wiring to Turn Off Thermostats Remotely

To use an external dry contact switch to turn a thermostat off remotely:

1. Wire the switch as shown in Figure 16.
2. In the Settings menu, set TT to OF.
 - When the switch is closed, the T-32-P turns off and the word OFF flashes on the LCD.
 - When the switch is opened, the thermostat returns to the user settings.

Figure 15. Wiring Diagram: Turning Off Sensors Remotely

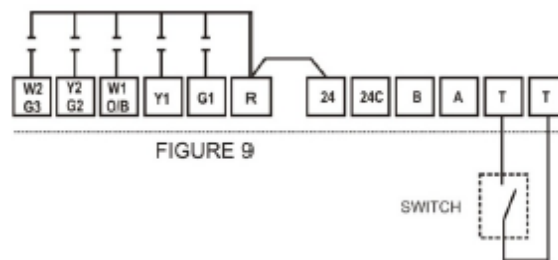

5.7. Wiring to Override Settings Remotely

To use an external dry contact switch to remotely change the heating and cooling setpoints to a pre-programmed override value:

1. Wire the switch as shown in Figure 16 above.
2. In the Settings menu:
 - a. Set TT to OC.
 - b. Use OC and OH to set the cooling and heating setpoints.
 - When the switch is closed, user setpoints are replaced by the pre-programmed override setpoints.
 - When the switch is open, thermostat user settings are restored.

6. Testing

When the T-32-P is powered, the LCD screen briefly displays important information as shown below.

Figure 16. Thermostat LCD Display

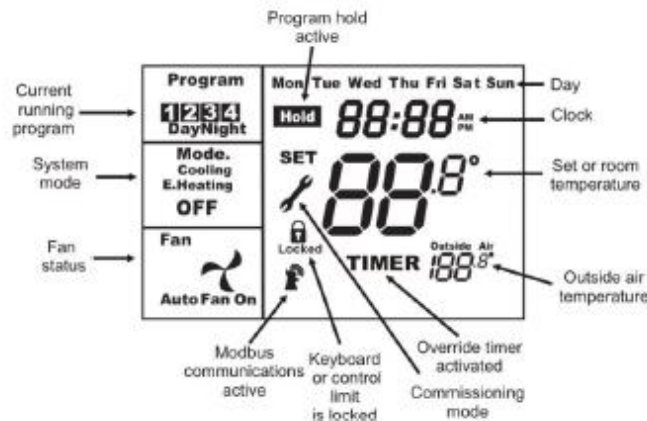

6.1. Disabling and Resetting Thermostat Delays

1. To disable time delays in the T-32-P to facilitate testing, in the Settings menu set CD to 1. After exiting the menu, a wrench icon flashes on the LCD screen as a reminder to reinstate the time delays when testing is completed.
2. To reinstate the time delays, in the Settings menu set CD to 0. The flashing wrench icon no longer appears on the LCD screen.

6.2. Testing Fan Operation

1. Press the MODE button until the word OFF is displayed on the LCD.
2. Press the FAN button and the words Fan On will appear. After a moment, the internal fan relay energizes, and the fan icon appears and rotates.

6.3. Testing Conventional Systems

1. Press the MODE button until Mode Heat appears on the LCD.
2. Use the ▲ button to raise the setpoint a few degrees above the space temperature. The heating relay will energize and the word Heat will change to Heating.
3. If the thermostat has been configured for multi-stage operation, raise the setpoint further and the second stage heating relay energizes and a period is displayed after the word Mode.
4. Press the MODE button until Mode Cool appears on the LCD.
5. Use the ▼ button to lower the setpoint a few degrees below the space temperature. The cooling and fan relays will energize and the word Cool will change to Cooling.
6. If the thermostat has been configured for multi-stage operation, lower the setpoint further and the second stage cooling relay energizes and a period is displayed after the word Mode.

6.4. Testing Heat Pumps

When the thermostat is in heat pump mode, the reversing valve is energized when it receives a call for cooling or heating. The reversing valve remains energized for 30 minutes unless there is an opposite call in the interim.

Testing a T-32-P configured for heat pumps is the same as testing for a conventional heating and cooling system except the fan relay is energized on a call for heating as well as for cooling.

Emergency Heat mode is active when the thermostat H3 setting is EH, FF or AL in the Settings menu. E. Heating is displayed on the LCD when either the thermostat is placed in emergency heat mode or the W2 relay is energized.

6.5. Using Factory Test Mode

The T-32-P contains a simple factory test mode that can be used to confirm relay outputs, switch configurations, or reset the thermostat to factory defaults.

Access the Settings menu and select one of following TS switch settings:

- 0 – Factory Test Mode is OFF.
- 1 – For factory use only. Displays system configuration code based on slide switch settings.
- 2 – Cycles each relay on and off in an endless loop. Equipment should be disabled when performing this test.
- 3 – Reset software to factory defaults. Press the Fan button to initiate.

7. Basic Troubleshooting

Table 6. Troubleshooting

Symptom	Potential Solution
No LCD Display	<ol style="list-style-type: none"> 1. Remove thermostat from subbase and check: <ol style="list-style-type: none"> a. For 24 volts across '24' and '24C' b. Factory jumper is between 'R' and '24'. 2. If no voltage, check voltage on HVAC for 24 volts at HVAC system terminals 'R' and 'C'. If no voltage, fault is equipment related. 3. If voltage, check wiring.
"Locked" appears on LCD screen and heating or cooling not operating	<p>If an outdoor sensor is being used, it could be preventing heating or cooling calls. Adjust the appropriate setting in the Settings menu if the outdoor air temperature is:</p> <ul style="list-style-type: none"> • Close to the OFF setpoint for heating or cooling • Above the heating OFF setpoint • Below the cooling OFF setpoint
Wrench icon flashes on LCD	Commission mode is enabled, and time delays are being overridden. Change CD to 0 in Settings menu.
Some thermostat buttons do not function	Lock values have been set. Refer to LC settings in the Settings menu.
Temperature displays inaccurate	<ul style="list-style-type: none"> • Air from the wall cavity may be leaking into the rear of the thermostat. Seal holes in the wall to prevent air infiltration. • The temperature sensor might be folded back inside the thermostat and is not being exposed to the room temperature. Carefully move the sensor head so that it is just behind the sensor opening in the case. • External influences from appliances, lighting or drafts may be affecting temperature accuracy. Move lamps or other sources of abnormal temperature influence away from the thermostat.
Outdoor temperature does not display (Dashes appear on the LCD screen)	<ul style="list-style-type: none"> • Check wiring to outdoor sensor. • Make sure that TT=OA in the Settings menu.
"Heating" or "Cooling" is flashing while the HVAC system is running	The T-32-P has a built-in minimum equipment run time of either 2 or 6 minutes. Sw6 may be set for 6 minutes (ON) which is keeping the equipment on after the thermostat reaches setpoint.
Lock icon flashes when trying to set a higher heating or lower cooling temperature	HL and CL restrict the heating and cooling setpoints. The setpoints can be changed in the Settings menu.
Thermostat displays wrong temperature scale	The T-32-P can be configured to use the Fahrenheit or Celsius scale. Change CF to C or F in the Settings menu.
Fan continues to run after a heating or cooling call is satisfied	<ul style="list-style-type: none"> • The thermostat is set to Fan ON. Set the thermostat to Auto Fan. • The fan purge mode is set to run the fan for a fixed period after the equipment shuts off. Change the FP value in the Settings menu.
Thermostat clock does not keep proper time	Make sure the plastic tab on the internal battery has been removed so that the battery is operational.

8. Specifications

Table 7. T-32-P Specifications

Input Voltage	24 VAC 50/60 Hz
Relay Rating	24 VAC @ 1Amp maximum per relay
Operating Temperature	32°F to 122°F
Operating RH	0-95% (non-condensing)
Storage Temperature	32°F to 105°F
Size	4-7/16" W x 4-1/16" H x 7/8" D
LCD Display Size	2-3/4" W x 1-7/8" H
Temperature Sensor	10K NTC type 3
Voltage	20-30 VAC
Resistance	10kΩ @ 77°F
Tolerance	+/- 3% @ 77°F
Stage Delays	Minimum temperature change over time
Timed Upstage Delay	5 to 90 minutes
Short-cycle Delay	Off to 4 minutes
Display Resolution	0.1° F
Control Range	Off to 105°F
Outdoor Air Temperature Range	-10°F to 140°F
Back Light	Blue EL (Electro Luminescent)
Optimized Start/Stop Method	Time to start vs. temperature differential
Communications Protocol	Modbus
Approvals	FCC (Part 15) (Pending)
Warranty	5 years



Autani LLC

7090 Columbia Gateway Drive, Suite 140, Columbia, MD 21046, USA,
(443) 320-2233 | (240) 755-0092 (fax) www.autani.com.

This document contains the Proprietary and Confidential Information of Autani, LLC. Any use of this information without the expressed written consent of Autani, LLC is prohibited. Copyright Autani, LLC, 2010-2020. All rights reserved. Please refer to www.autani.com/legal for licensing, intellectual property, and other legal notices and information.